



P R O F E S S I O N A L

## **NRS-AP10**

750Mbps Dual-Radio Ultra Wide Range Wireless Access Point

## **NRS-RC1**

4-port Smart router/controller PoE+ Gigabit Switch

**User Manual**

**Version 2.2**

---

This manual is subject to tell users how to use this CAPWAP Broad Band Router with WLAN Controller and PoE Switch function, suit for those familiar with basic networking knowledge and terminology, Then this user manual including the product main features, packing content, hardware introduce and AC Controller, Routing, Firewall, Management. Pre-reading this manual before operation is highly recommended;

Pls note: MR series broadband router work with wireless access point mainly as the PoE ports supply max 8 PoE power for the PD equipment.

# Table of Contents

---

## Table of Contents

Chapter 1: Product Instruction, Default Data, Packing	5
1.1 Product Instruction	6
1.2 Default Data	7
1.3 Packing and Accessory	7
Chapter 2: Hardware Introduce	8
2.1 Hardware	9
2.2 Installation	9
Chapter 3: Login	10
Chapter 4: WEB GUI Configuration	12
4.1. User Manager	14
4.2. AC	15
4.2.1 Device List	15
4.2.2: Address Server	17
4.2.3: Zero Config	17
4.2.4: Device Log	20
4.3 LAN Settings	21
4.3.1 LAN Setting	21
4.3.2 Static DHCP	21
4.4. WAN	22
4.4.1 WAN Setting	22
4.4.2 Advanced Setting	23
4.5. URL Filter	23
4.6 Behaviour Control	24
4.7 Timed Reboot	26
4.8 Upgrade Firmware	26
4.9 Advanced Settings	27
4.9.1 Common	27
4.9.1.1: AC Setting	27
4.9.1.2: IP/Time Group	27
4.9.1.3: Behaviour	27
4.9.1.4: User Manager	27
4.9.1.5 Flow Control	27
4.9.1.6 Cloud Server Setting	27
4.9.2 Network	28
4.9.2.1: LAN Settings	28
4.9.2.2: WAN Settings	28
4.9.2.3: DDNS	29
4.9.3 Security	29
4.9.3.1 URL Filter	29
4.9.3.2 IP Filter	30
4.9.3.3 MAC Filter	30
4.9.3.4 Port Mapping	31
4.9.3.5 DMZ	32
4.9.4 Device	32
4.9.4.1 Configure	32
4.9.4.2 Reboot	33
4.9.4.3 Modify Password	33
4.9.4.4 Firmware Upgrade	33

# Table of Contents

---

4.9.4.5 Device Time-----34  
4.9.4.6. Device Log-----34

## **Chapter 1:**

### **Product Instruction, Default Data, Packing**

- **Product Instruction**
- **Default Data**
- **Packing**

## 1.1. Product Instruction

MR series broad band router is an CAPWAP home use router with WLAN Controller and PoE switch functions. Build in network/electronic distribution box, it supply Ethernet for PC, IPTV or other entertainment device, then supply PoE power and Ethernet together for in wall wireless AP to bring seamless wireless coverage for each corner. The working diagram showed as follow:



## 1.2 Default Data:

Management IP address & LAN IP address: 192.168.18.1

Login Password: admin

## 1.3 Packing and Accessory

- Broad Band Router
- Power Adapter (26W or 72W)
- Power Cord
- User Manual

## **Chapter 2:**

### **Hardware Introduce**

- **Hardware**
- **Installation**



## 2.1 Hardware

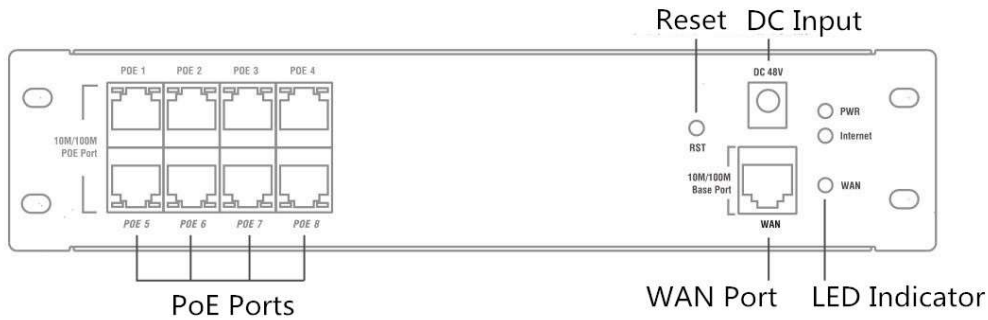

**WAN:** Ethernet Port, connect with ADSL Modem mainly.

**DC Input:** Can be 48V or 24V, we take 48V for example; Pls note: If 48V DC input, then the PoE ports can supply 48V PoE out for PD equipment. If 24V DC Input, then the PoE ports support passive PoE, supply 24V Passive PoE for PD equipment.

**Reset:** Press 10 seconds to revert to factory default data

**LED Indicator:** to show the working status of Internet, Power

**PoE Ports:** Work with 48V PD equipment to supply Ethernet and 48V PoE Power; Work with PC as LAN port to supply Ethernet

## 2.2 Installation

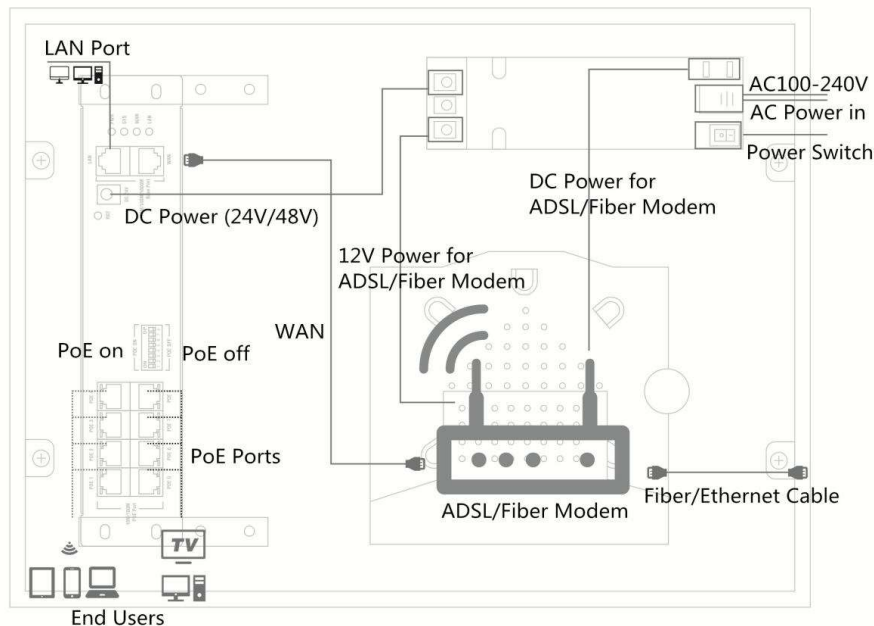

## Chapter 3:

### Login

## Chapter 3: Login

- A. Confirm the PoE ports is 48V PoE or 24V Passive PoE; If 24V Passive PoE, pls disable PoE power first by the PoE on/off switch, then connect LAN ports with PC.
- B. Connect LAN Port with PC, then PC will get IP address: 192.168.18.X (X is number from 2~254, The default LAN IP address is 192.168.18.1)

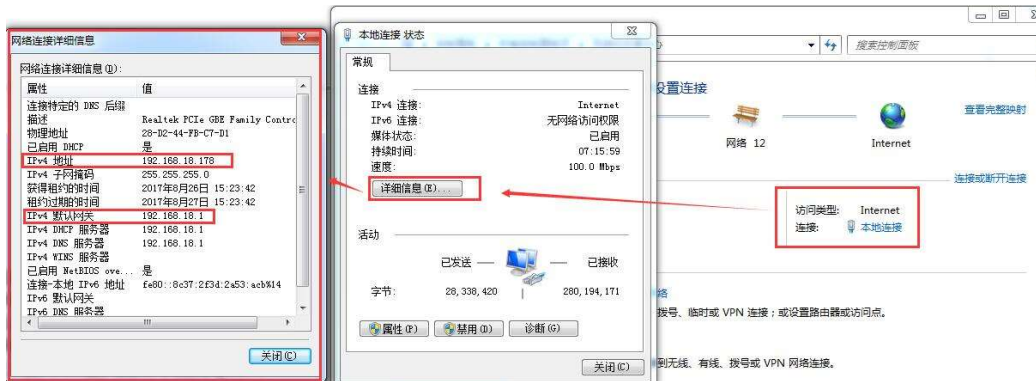

- C. Open IE browser, input broad band router's IP address **192.168.18.1**, Enter to log in this broad band router's WEB GUI.
- D. Choose the Language, then input **admin** and Login

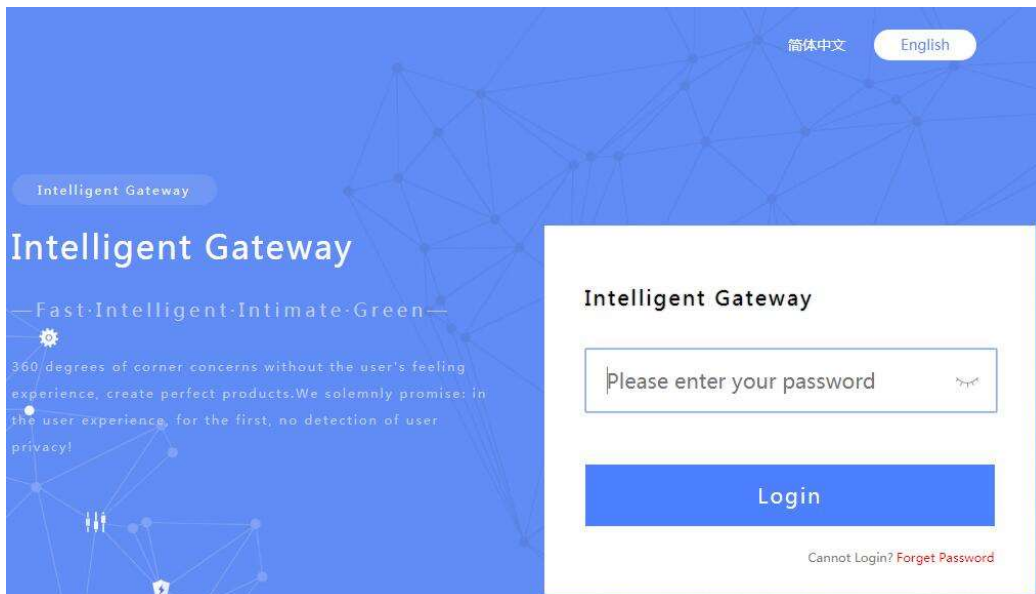

## Chapter 4:

### WEB GUI Configuration

- **User Manager**
- **AC**
- **LAN Settings**
- **WAN**
- **URL Filter**
- **Behaviour Control**
- **Timed Reboot**
- **Upgrade Firmware**
- **Advanced Settings**

## Chapter 4: WEB GUI Configuration

When login this broad band router, the following home page will pop up as follow:

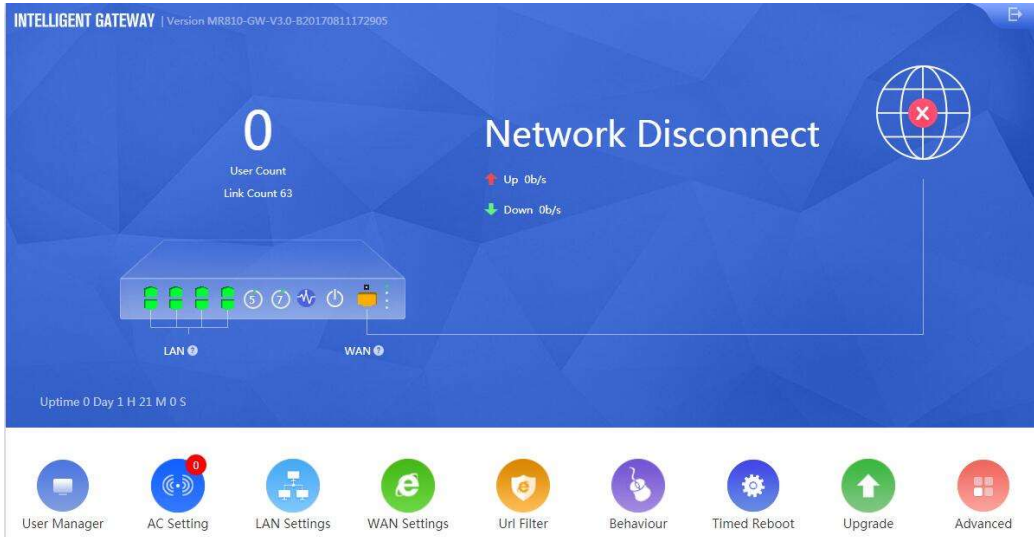

Version: Show firmware version



: Exist this GUI WEB



: To manage the online users, click it to user manager page



: Click to check the LAN status



: Click to set the WAN Setting



: Here show the CPU and Memory capacity



: Timed Reboot: To set up the reboot time;



: Reboot the broad band router



: Ethernet working status, click to WAN setting page.

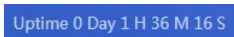

: The broad band router running time.

Let's introduce User Manager, AC Setting, LAN Setting, WAN Setting, Uri Filter, Behaviour, Timed Reboot, Upgrade, Advanced functions one by one to make users with more understanding in this product.

## 4. 1. User Manager

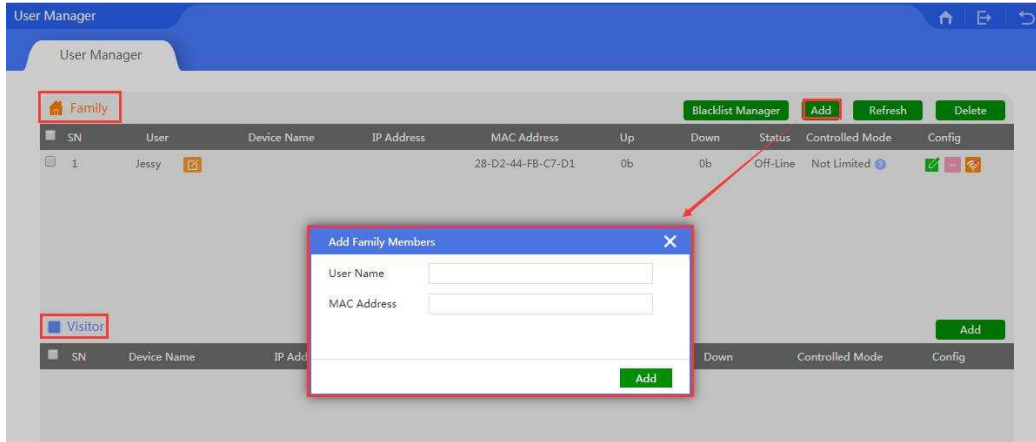

In user manager, can manage the network behavior of family members and visitors.

**Add:** Add the MAC which will be managed, configuration showed in above picture.

**Blacklist Manager:** Mean add the MAC address into black name, prohibit it Ethernet behavior, configuration showed as following picture;

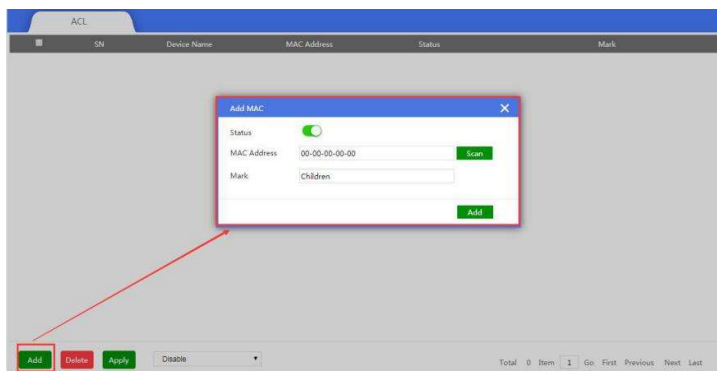

**Config:** To controller the Ethernet behavior or Ethernet time, configuration showed as follow

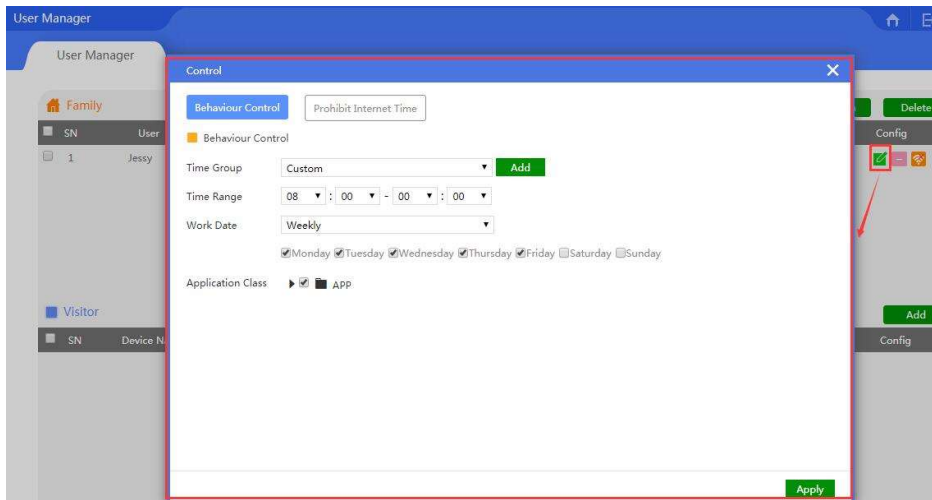

## 4. 2. AC

This broad band router with WLAN controller function, which can manage, control and configure the connected in wall wireless access point

Click button of AC, it will pop up following picture, which showed all the wireless AP connected into this broad band router;

### 4.2.1 Device List

Device List to show the online/offline wireless AP list; Online wireless AP with green color, Offline wireless AP with red color.

	Device List	Zero Config	Device Log	Address Server								
	SN	Name	IP	MAC	SSID	Users	Channel	Txpower	Device Model	Uptime	Config	
	1		192.168.200.39	44:d1:fa:0d:ac:91	Wireless 2.4G	0	0	100%	FIT-MB520	0:01:30		
	2		192.168.200.87	44:d1:fa:13:4e:c0	Wireless 2.4G12121212	0	10/0	100%/100%	FIT-MB740	0:04:28		

All AP 2/20    Online AP 1    Offline AP 1    Wlan Users 0    All AP    Batch Set    Delete    Reboot    Reset    Upgrade

**All AP:** Show QTY of wireless AP which connected with this WLAN controller; 20 mean max to manage 20PCS wireless AP.

**Offline AP:** Show QTY of wireless AP which offline already

**Online AP:** Show QTY of wireless AP which online

# User Manual NRS-AP10 and NRS-RC1

---

**WLAN Users:** Show QTY of end users which access into wireless AP.

**Batch Set:** Set Channel, TX Power, Time to restart, Max users, device login password in batch.

**Delete:** Delete the chosen wireless AP from this device list.

**Reboot:** Restart this wireless AP

**Reset:** return to factory default

**Upgrade:** Upgrade firmware.

: if tick it, mean select all the wireless AP; If tick  here, mean select this wireless AP;

**Name** : Can mark AP the location or model number other information which easy to know this wireless AP.

**IP:** The wireless AP's IP address

**MAC:** MAC address of wireless AP

**SSID:** Show the SSID of device 1 and device 2

**Users:** Mean how many users connected with this wireless AP

**Channel:** Show this wireless AP's channel, including device 1 and device 2

**TxPower:** Mean the wireless AP's RF power

**Device Model:** Model number of this wireless AP

**Uptime:** running time

**Config** : to check the wireless AP's working status, configure the wireless AP's basic and advanced data.





## 4.2.2: Address Server:

Address Server: Mean this AC controller can assign IP address for wireless AP automatic, no need to change wireless AP's IP address one by one

SN	Name	IP	MAC	Lease Time
1	FIT-MB520	192.168.200.39	44-D1-FA-0D-AC-91	0 D 00:55:36

**Refresh:** to refresh the wireless AP's IP address

**Function:** Enable/Disable, default is Enable

**Server IP address:** default is 192.168.200.1; can change to anyone you like, but pls note, if server IP is 192.168.200.1, then wireless AP's IP address will be one from 192.168.200.2 to 192.168.200.254

**Server Address Count:** default is 100, can be 1~100, based on the QTY of wireless AP.

**Effective Time:** can be 1~24 hours

**Allocated AP number:** show the QTY of wireless AP which assigned IP address by this WLAN controller.

When setup the above data, click Apply to save it.

**AP address information list:** to show wireless AP's model number, IP address, MAC address and running time.

## 4.2.3: Zero Config

This function make wireless AP plug and play, but recommend to configure this function before connect wireless AP into this network as following reason:

1. If configure this function after wireless AP connected into this network, then all wireless AP should be reboot, then wireless AP will get the configuration from Zero config.
2. There is one group only in Zero config, which will make all wireless AP in same SSID, password, channel...

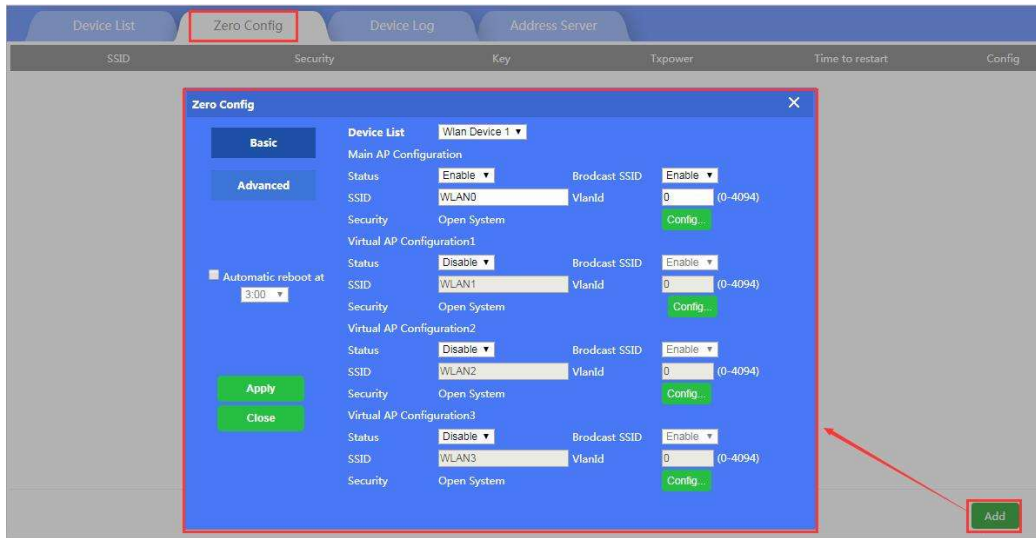

**Wireless Basic:** to setup wireless AP's SSID, password, Tag VLAN

**Device List:** Wlan Device 1 and Wlan Device 2; Wlan Device 1 mean 2.4G Radio mainly; Wlan Device 2 mean 2.4G or 5.8G radio, based on wireless AP.

**Main AP Configuration:** setup the wireless AP's main SSID, Tag VLAN, Configure Password.

**Virtual AP Configuration:** setup the wireless AP's virtual SSID, Tag VLAN, Configure Password. The default status is disable for this virtual SSID.

**Automatic Reboot at:** Mean can setup this wireless AP reboot at certain time automatic, to improve the performance.

**Wireless Advanced:** to set up the channel, RF power, ShortGI, Coverage Threshold of wireless AP

The screenshot shows the 'Zero Config' window with the 'Advanced' tab selected. The settings are as follows:

Setting	Value	Range
Device List	Wlan Device 1	
Channel	Auto	
WLAN Partition	Disable	
Fragment Threshold	2346	(256-2346)
RTS Threshold	2346	(1-2347)
Beacon Interval	100	(50-1024)ms
Aggregation	Enable	
ShortGI	Enable	
Rev Option	5	
RF Output Power	100%	
Coverage Threshold	-90	(-65dBm~-95dBm)

Additional settings on the left:

- Automatic reboot at:  3:00
- Buttons: Apply, Close

**Channel:** Auto in default, but recommend to setup channel by manual based on environment.

**RF Output Power:** 100%, 75%, 50%, 25%, 12.5%, can adjust it based on application. More RF Power, mean more WiFi Range;

**Coverage Threshold:** This make end users to connect the outdoor CPE with stronger signal strength;

For example, If one outdoor CPE with -80dBm coverage threshold data, another outdoor CPE with -95dBm coverage threshold data, then end users will connect the outdoor CPE with -95dBm coverage threshold always even this outdoor CPE with very weak signal strength.

After setup all the data, click Apply to add zero config group as follow:

Pls note, click config button  , can modify the data if need.

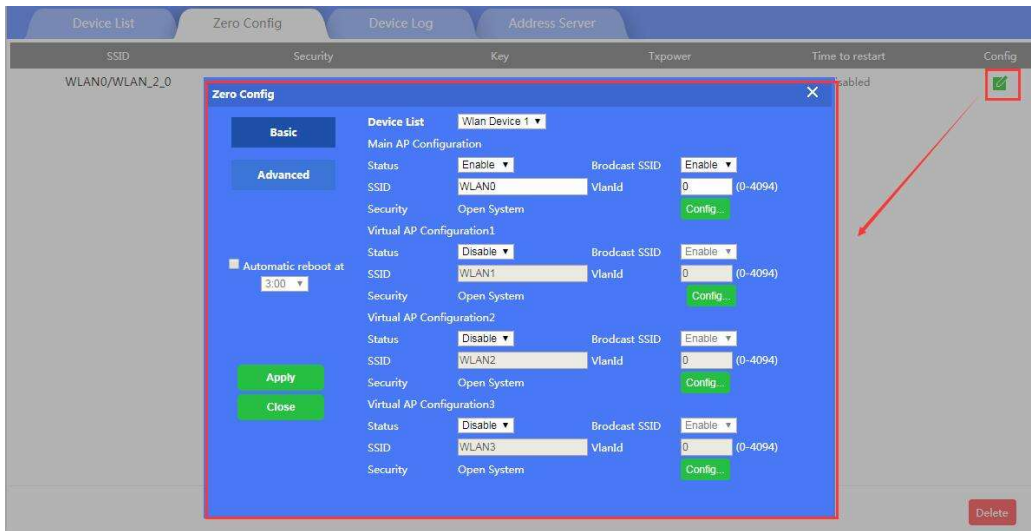

**Delete:** If need, can delete this zero config.

## 4.2.4: Device Log

Device Log is keeping the operation record of this WLAN controller.

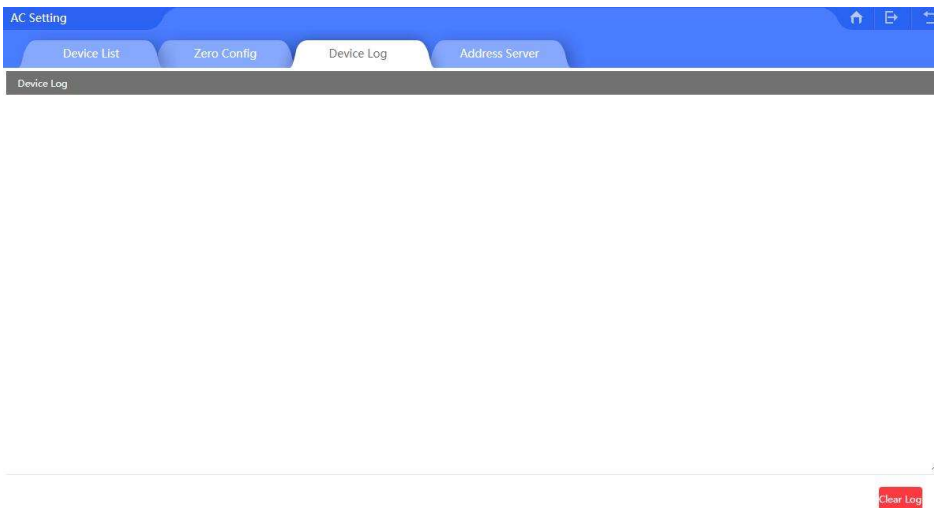

## 4.3 LAN Settings

This including LAN setting and Static DHCP

### 4.3.1 LAN Setting:

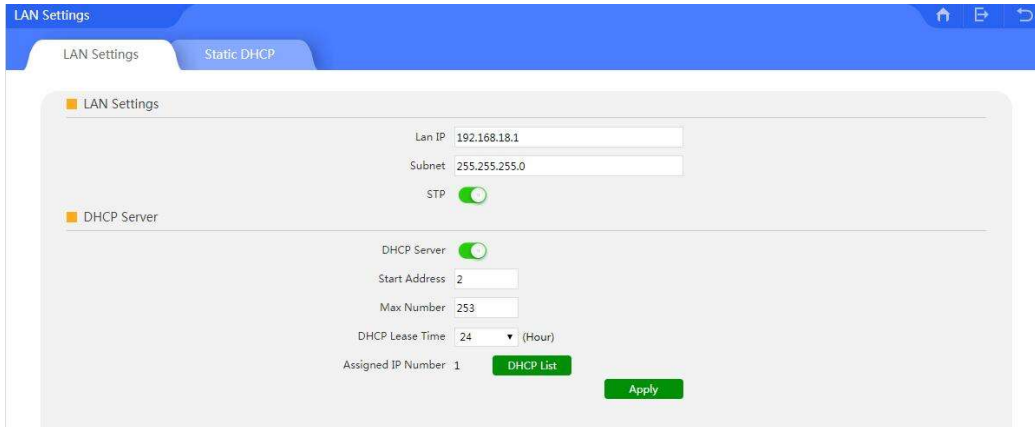

The screenshot shows the LAN Settings configuration page. It has two tabs: 'LAN Settings' and 'Static DHCP'. The 'LAN Settings' tab is active. It contains the following fields and controls:

- Lan IP: 192.168.18.1
- Subnet: 255.255.255.0
- STP:
- DHCP Server:
- Start Address: 2
- Max Number: 253
- DHCP Lease Time: 24 (Hour)
- Assigned IP Number: 1
- Buttons: 'DHCP List' and 'Apply'

**IP address:** mean AC controller's IP address

**Subnet Mask:** to set the subnet of LAN

**STP:** Spanning Tree: Enable to show the assigned IP list in DHCP list; Disable mean will not show it.

**DHCP Server:** Enable mean can assign IP address automatic.

**Start Address:** The started DHCP IP address

**Max Number:** QTY of max DHCP address

**DHCP Lease Time:** the IP address lease time by DHCP server

**Assigned IP Number:** QTY of IP address that DHCP assigned.

### 4.3.2 Static DHCP

**Static DHCP:** Banding certain users with certain IP address by scan MAC address and IP address;

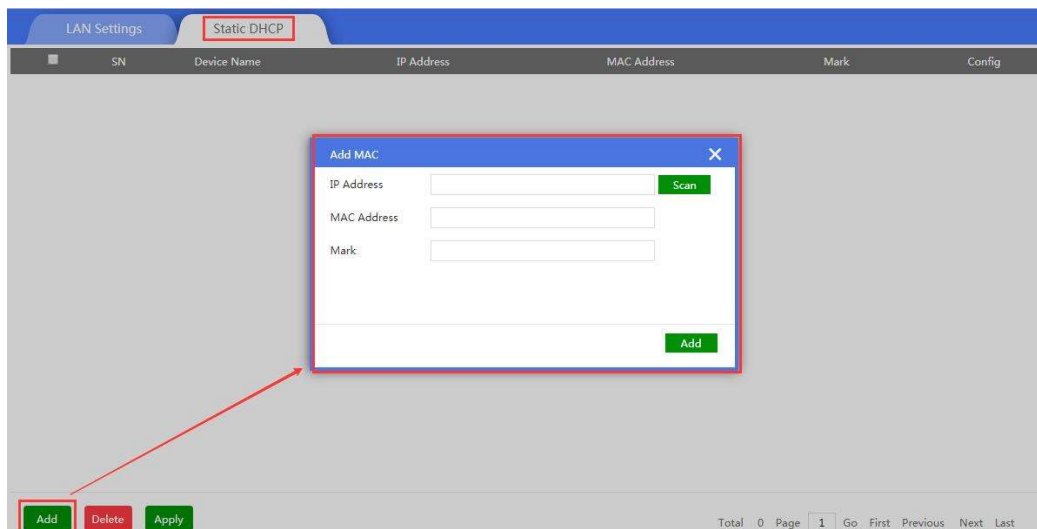

The screenshot shows the Static DHCP configuration page. It has two tabs: 'LAN Settings' and 'Static DHCP'. The 'Static DHCP' tab is active. It contains a table with columns: SN, Device Name, IP Address, MAC Address, Mark, and Config. Below the table is an 'Add MAC' dialog box with the following fields and controls:

- IP Address:  Scan
- MAC Address:
- Mark:
- Buttons: 'Add' and 'Add'

At the bottom of the page, there are buttons: 'Add', 'Delete', and 'Apply'. A red arrow points from the 'Add' button to the 'Add MAC' dialog box. The bottom right corner shows 'Total 0 Page 1 Go First Previous Next Last'.

## 4.4. WAN

For the MR series product, the default operation mode is gateway.

### 4.4.1 WAN Setting:

In WAN Setting, including DHCP, Static IP, PPPoE, showed as following picture:

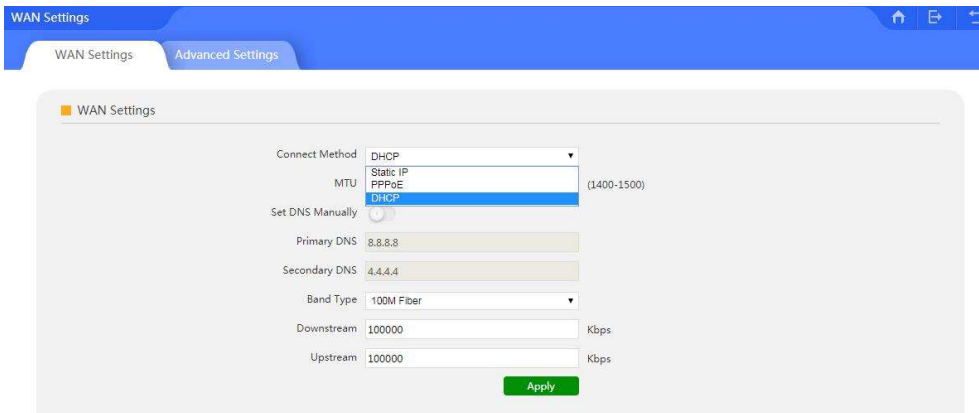

Static IP: Assign IP address and DNS information to get the Ethernet

PPPoE: Dial up the PPPoE number to get the Ethernet

DHCP: Get Ethernet from router's DHCP.

Downstream: Download bandwidth of Ethernet;

Upstream: Upload bandwidth of Ethernet.

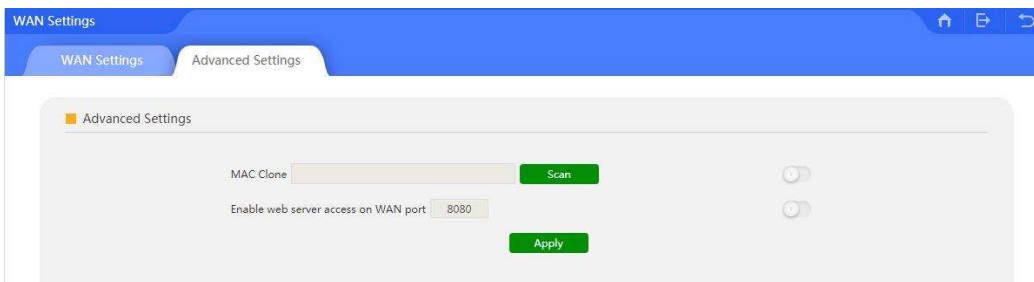

## 4.4.2 Advanced Setting:

In Advanced Setting, mainly to show MAC Clone and Remote Management

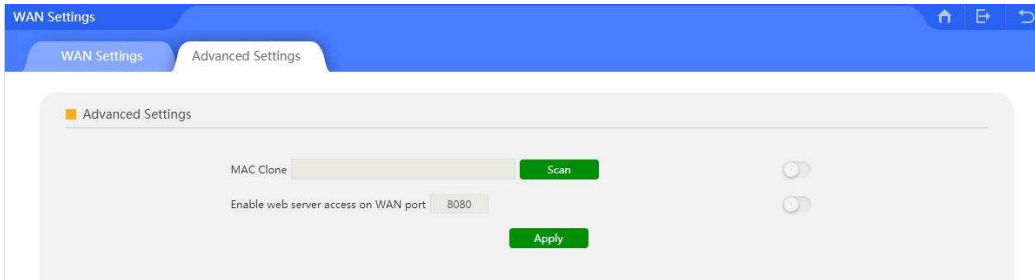

MAC Clone: When enable it, can scan the connected device's MAC address, choose the MAC address needed to be cloned, then apply; Or can input the indicated MAC to clone.

Port Remote Management

Enable the remote management port, manager can access into the WEB interface even in another Ethernet.

## 4.5. URL Filter

When enable URL filter, this will prohibit the users to visit some URL in certain time;

When click URL filter, pls setup the URL rule, add the time group, configure the limited time range and input URL to finish.

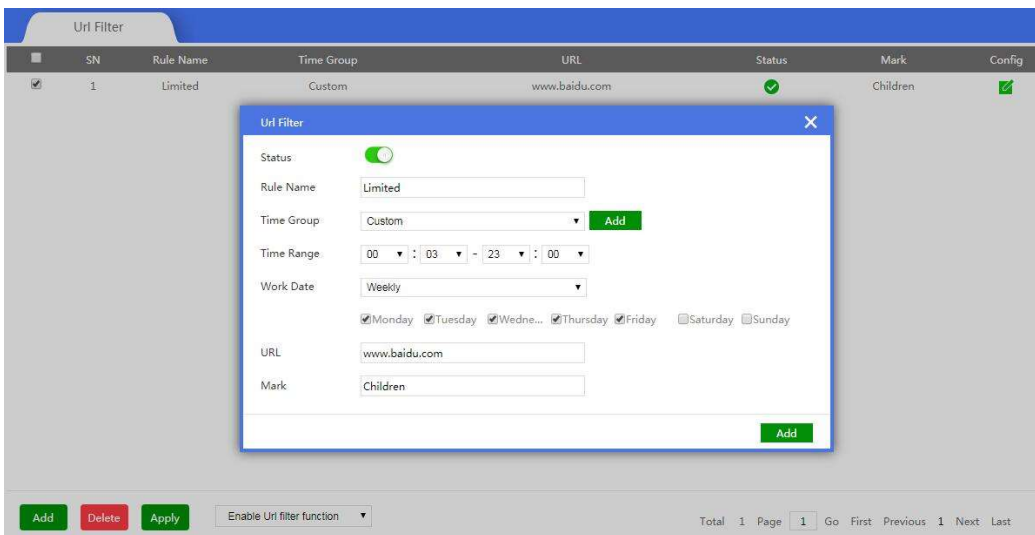

## 4.6 Behavior Control

In behavior part, it allow/reject end users some behavior based on rules.

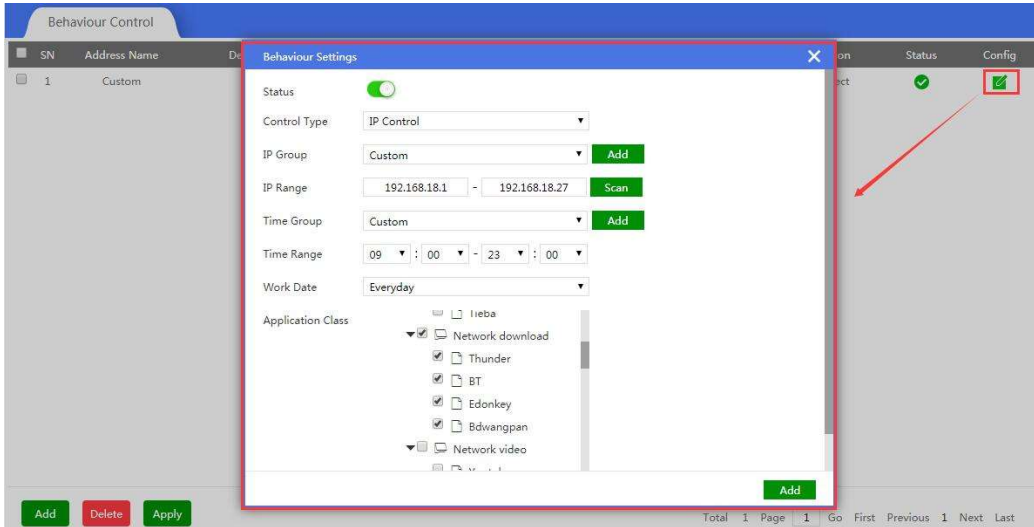

**Status:** Enable or Disable

**IP Group:** Can add the IP group if need based on following picture

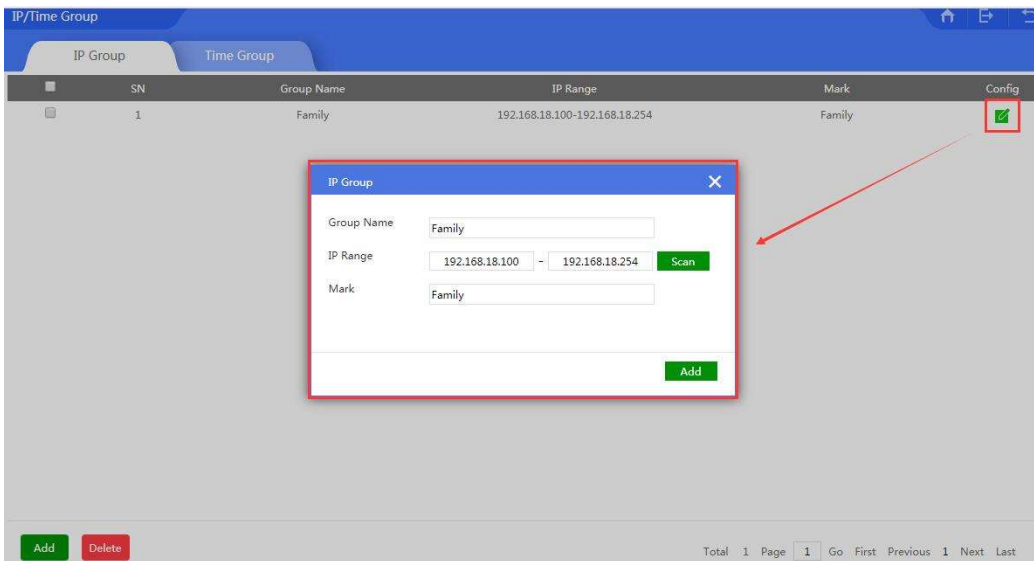



## User Manual NRS-AP10 and NRS-RC1

---

**Time Group:** Can add time group based on requirement in following picture:

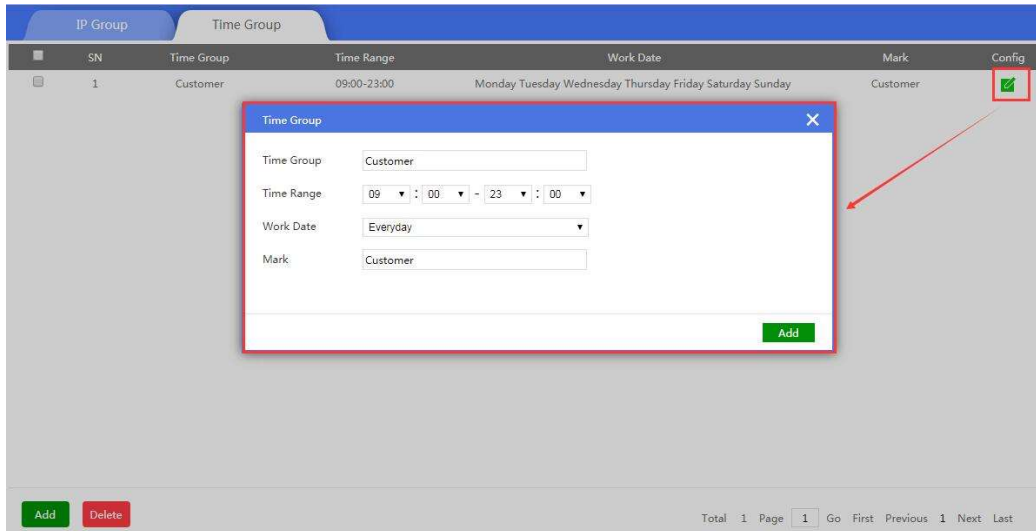

### **Application Class:** Including

Instant messaging (QQ, Trade Manager, WeChat);

Network Download (Thunder, BT, Edonkey);

Network Video (Youtube, PPTV, Tencent Video, Ppstream, Youku, Sohu Video, Letv, RSTP, Douyu, Storm web version, funsh, YY)

Office ( FTP, DNS, Http, NTP, NFS, DHCP, RTSP, IRC, Telnet, Stun, System Log, IPSEC, IGMP, SSH, TFTP, PPTP, Radius, OpenVPN)

Finance and other ( ICMP, Flush, DZH, Eastmoney)

## 4.7 Timed Reboot

In this part, it show the auto reboot time;

The default setting is disable, when enable it, it can reboot everyday.

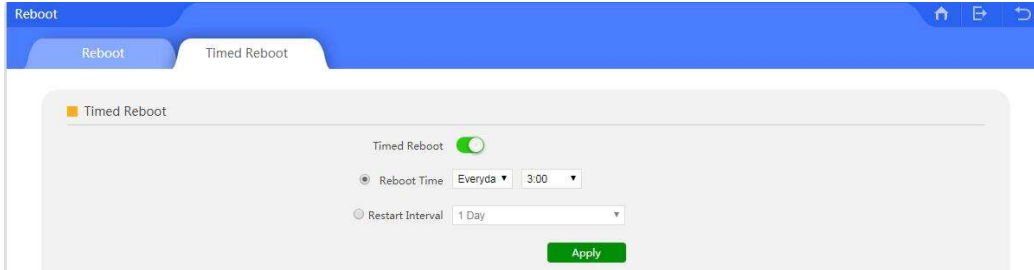

## 4.8 Upgrade Firmware

This feature allows the device firmware upgrade.

**Noted:**Upgrading software may cause system outage, In the process of upgrading the firmware, do not power off, otherwise it may damage the broadband router!

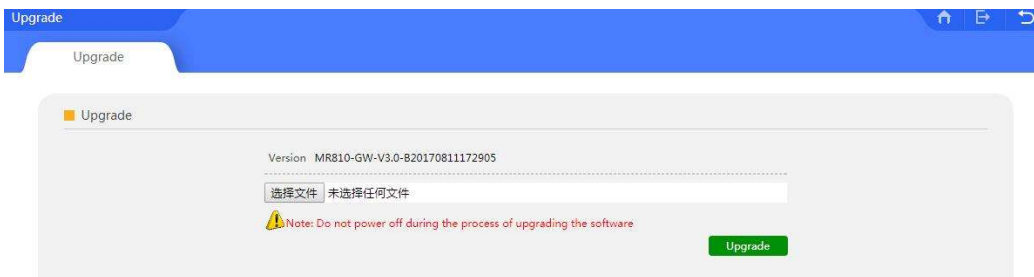

## 4.9 Advanced Settings

In advanced Settings, it including the common broadband router setting ; Network setting, Security setting and Device setting.

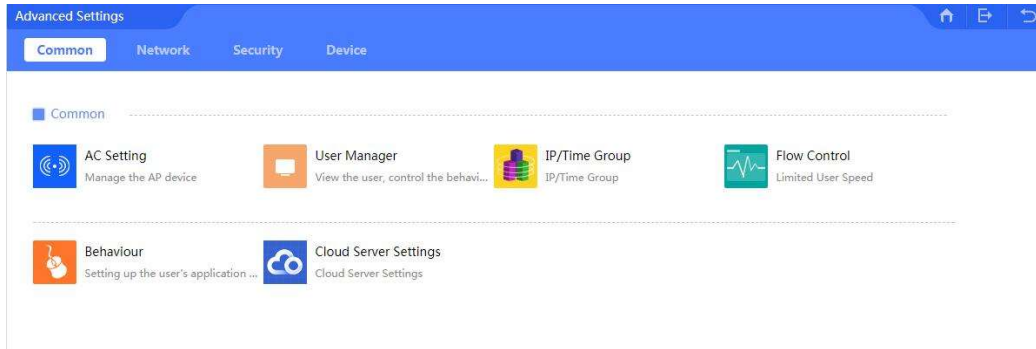

### 4.9.1 Common

#### 4.9.1.1: AC Setting:

For this part, pls refer to Chapter 4, 4.2 AC Part.

#### 4.9.1.2: IP/Time Group

For this part, pls refer to Chapter 4, 4.6 Behavior Control

#### 4.9.1.3: Behavior

For this part, pls refer to Chapter 4, 4.6 Behavior Control

#### 4.9.1.4: User Manager

For this part, pls refer to Chapter 4, 4.1 User Manager

#### 4.9.1.5 Flow Control

Flow Control mean Ethernet speed limit, to limit end users Ethernet speed;

Should add IP group first, then choose the limited mode.

Pls note: Shared Mode: mean all end users in this IP group share the downstream and upstream Ethernet speed; Exclusive Mode mean each end users in this IP group get the downstream and upstream.

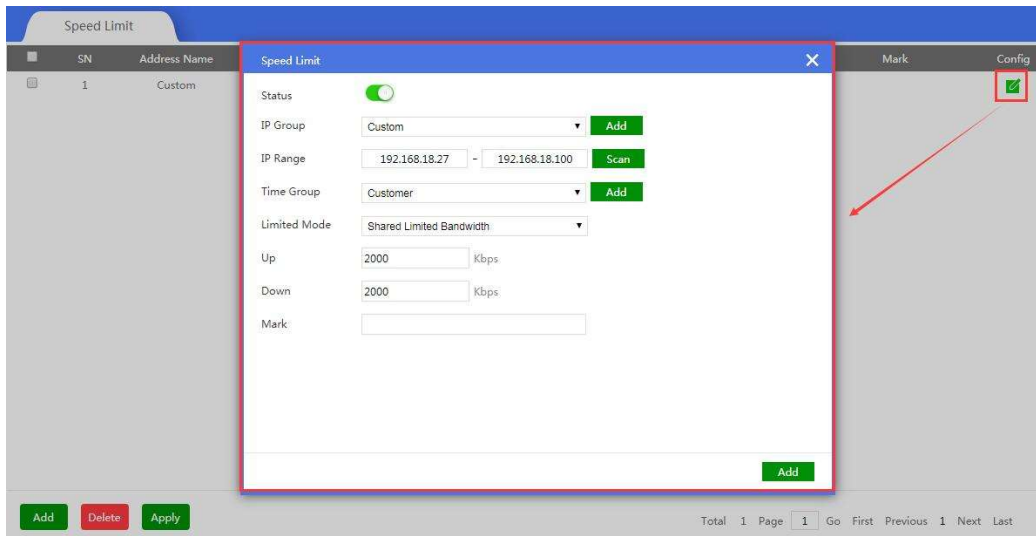

## 4.9.2 Network

In Network part, including LAN Settings, WAN Settings and DDNS settings.

### 4.9.2.1: LAN Settings:

For this part, pls refer to Chapter 4, 4.3 LAN

### 4.9.2.2: WAN Settings:

For this part, pls refer to Chapter 4, 4.4 WAN

### 4.9.2.3: DDNS:

DDNS or Dynamic DNS, is a method of automatically updating a name server in the Domain Name System(DNS), often in real time, with the active DDNS configuration of its configured hostname, address or other information.

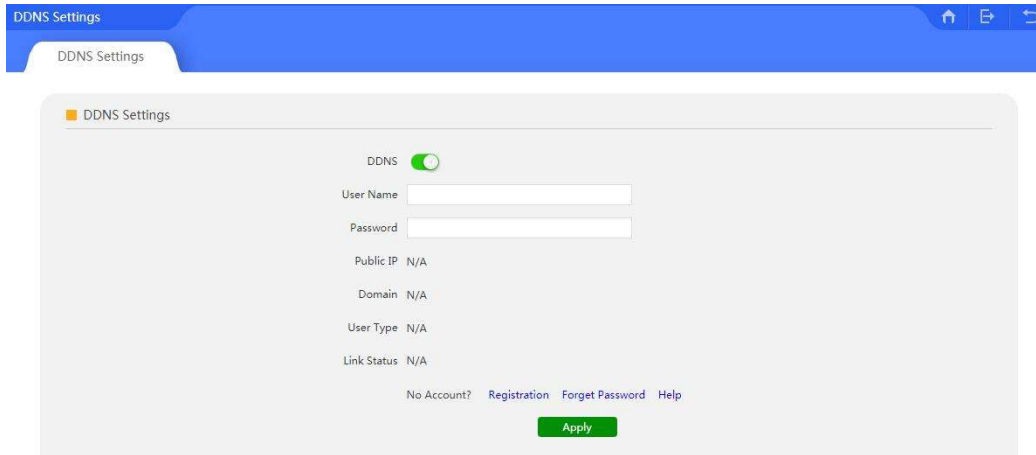

### 4.9.3 Security

In this part, including port mapping, IP Filter, Url Filter, MAC Filter, MAC Filter, DMZ

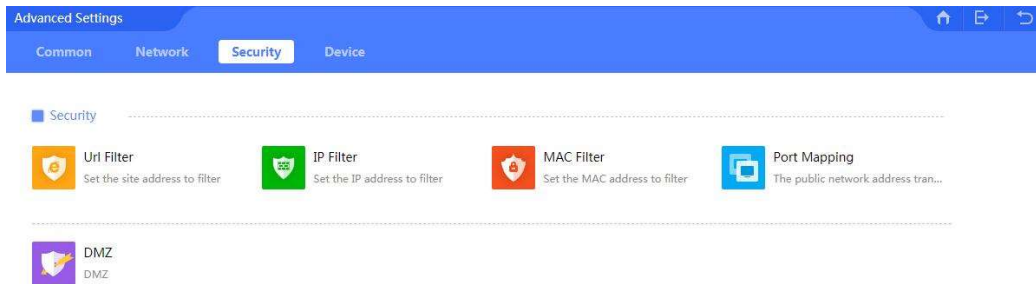

#### 4.9.3.1 URL Filter

For this part, pls refer to chapter 4, 4.5 URL Filter part.

## 4.9.3.2 IP Filter

When enable this function, router will allow or limited this IP address to access into this broadband router based on rules.

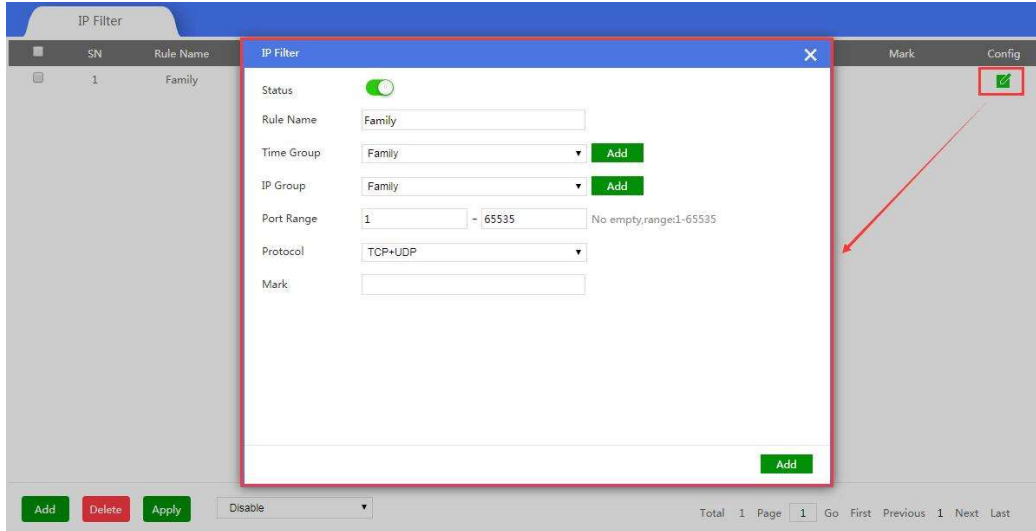

## 4.9.3.3 MAC Filter

When enable MAC filter, router will allow or prohibit this MAC address to access into this router based on rules.

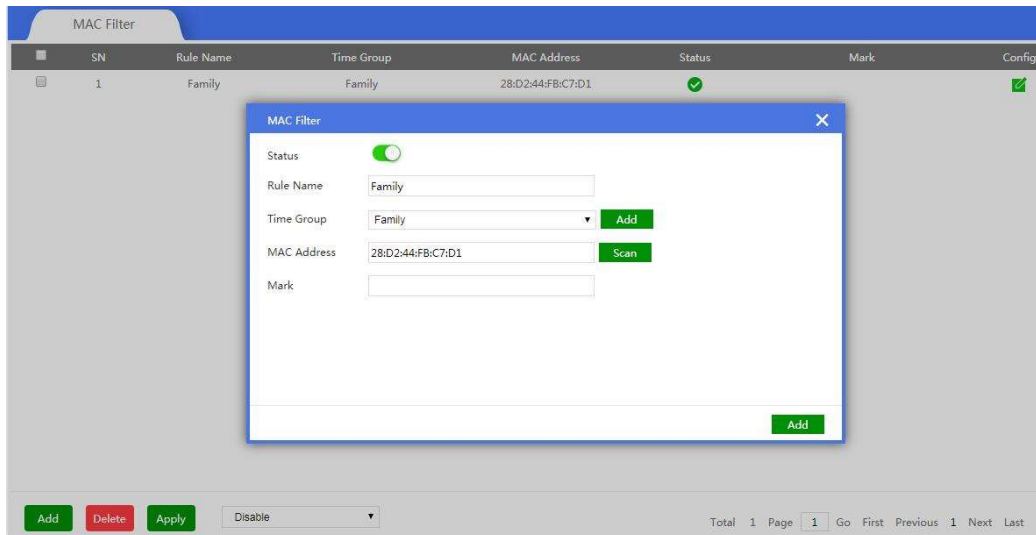

## 4.9.3.4 Port Mapping

Port forwarding: called port forwarding also, it an application of network address translation(NAT) that redirects a communication request from one address and port number combination to another while the packets are traversing a network gateway, such as a router or firewall

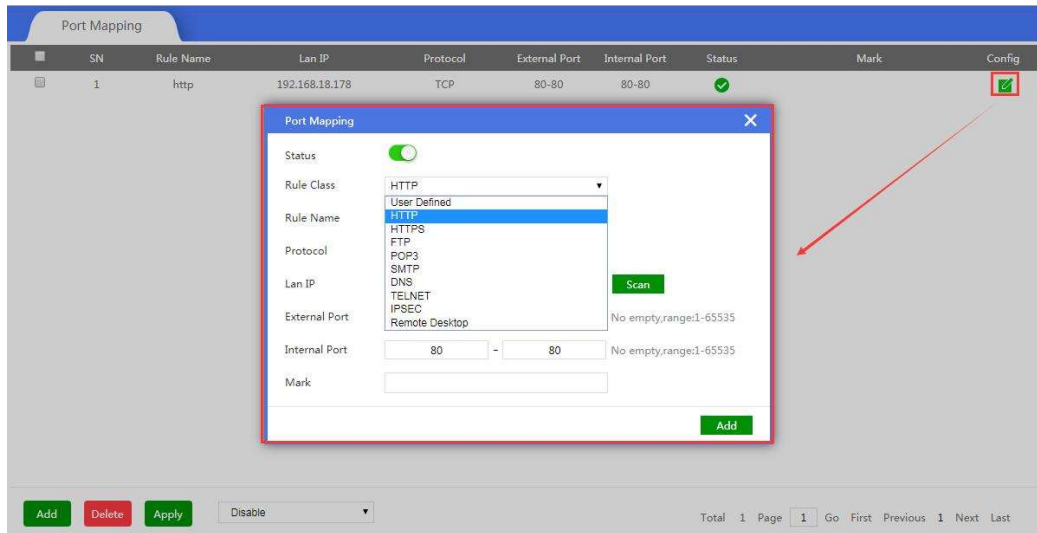

**Status:** Enable/Disable

**Rule Class:** Including user defined, http, https, FTP, POP3, SMTP, DNS, telnet, IPSEC, Remote Desktop

**Rule name:** Show the name of choosed rule class;

**Protocol:** Including TCP, UDP, TCP+UDP

**LAN IP:** port mapping LAN IP address

**External Port:** Set external port rule

**Internet Port:** Set internal port rule

**Mark:** the Ethernet Line which will be applied in this rules

## 4.9.3.5 DMZ

DMZ or Demilitarized Zone is a physical or logical subnetwork that contains an exposes an organization's external-facing service to a usually larger and untrusted network, usually the Internet. The purpose of a DMZ is to add an additional layer of security to an organization's local area network, an external network node can access only what is exposed in the DMZ, while the rest of organization's network is firewall.

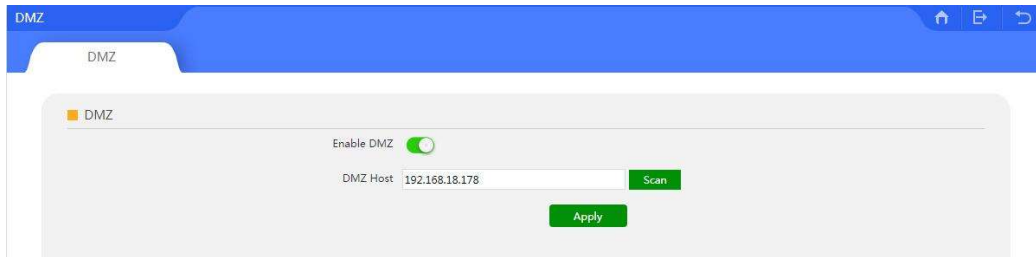

## 4.9.4 Device

This is configuration and management for broadband router, such as Configure, Reboot, Modify password, Upgrade firmware, Time reboot and Log.

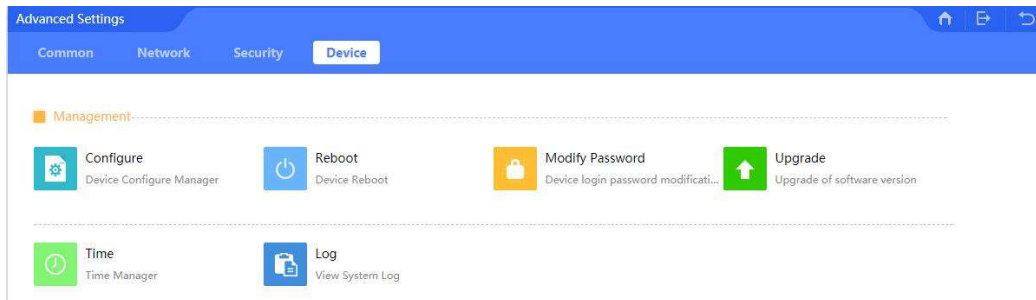

### 4.9.4.1 Configure

In this part, including the broadband router backup, restore, reset default.

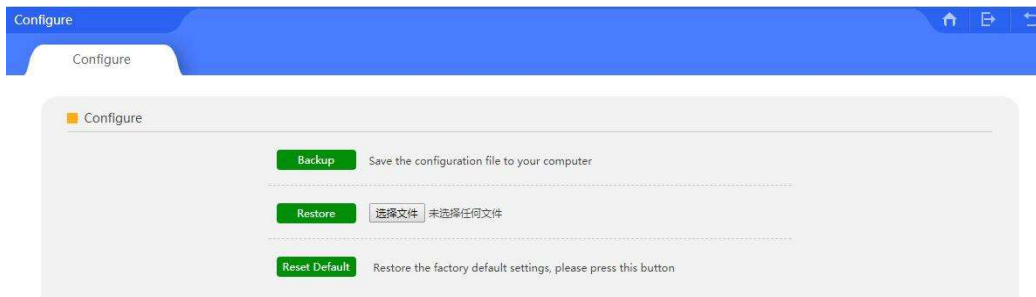

### Backup

Save the WLAN controller configuration file to your computer, can restore to the same configuration if restore this file.



## Restore

Using the saved configuration file to recovery configuration

### Restore default

Restore the factory default settings, please press this button

### 4.9.4.2 Reboot

In this part, mainly to reboot the broadband router now or reboot this broadband router in certain time

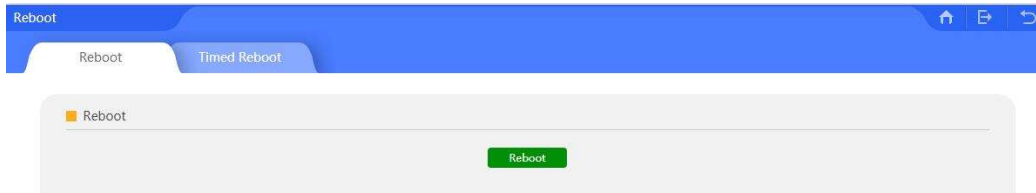

### 4.9.4.3 Modify Password

Modify the login password of this broadband router

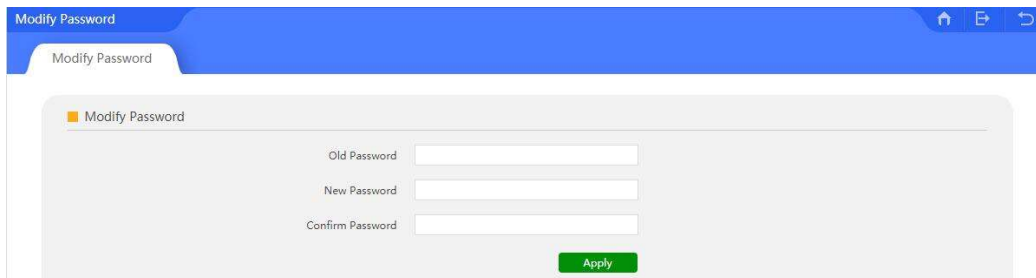

### 4.9.4.4 Firmware Upgrade

For this part, pls refer to Chapter 4, 4.8 Upgrade Firmware.

## 4.9.4.5 Device Time

To show the broadband router's time.

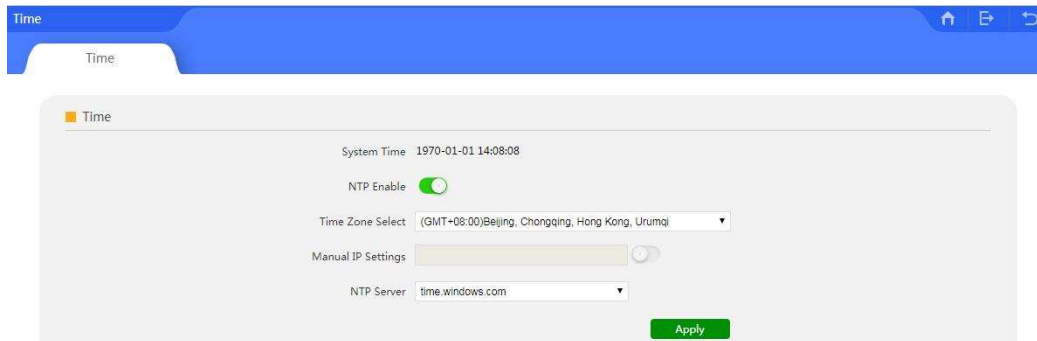

### Sync with the host

Synchronization time with connected PC and router

### NTP Eable

Enable or Disable NTP

### NTP Server

Select the server time synchronization

### Manual IP Setting

Setting user-defined IP address

### Time Zone Select

Setting the router's time zone

### Manual IP Settings

Setup the manual IP address

## 4.9.4.6. Device Log

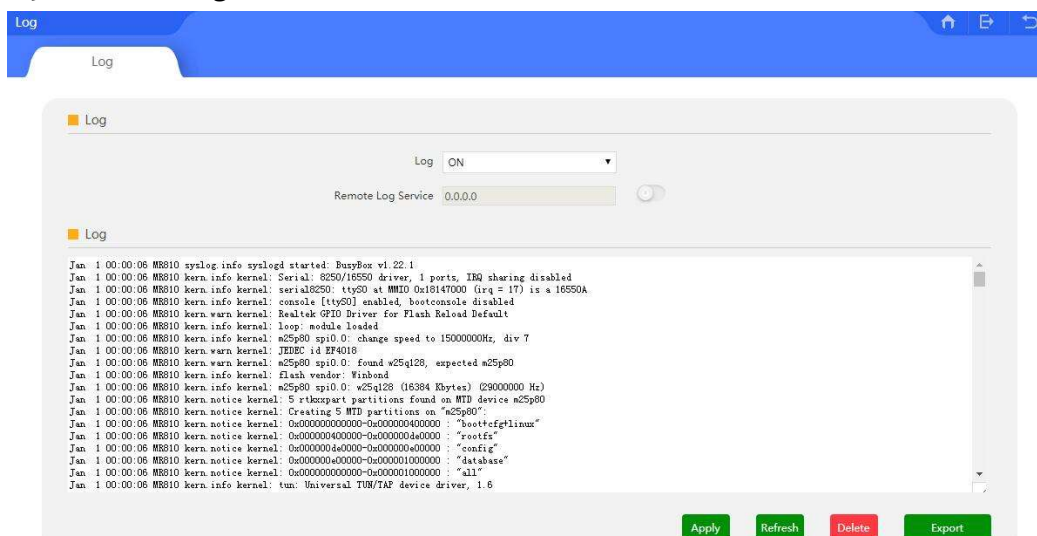

### **Device Log**

Enable or Disable to show system log

### **Remote Log Service**

To decide whether send System log into some pointed remote server synchronously;